



Compact Glass

SV-X70

COMPACT GLASS

BIBLIOTECA
DE DESCARGAS



DOWNLOADS LIBRARY |
BIBLIOTHÈQUE
TÉLÉCHARGEMENTS

ES

SV-X70 es un sistema de puerta corredera para paneles de vidrio sin marco que combina las últimas novedades tecnológicas con un atractivo diseño minimalista. El sistema se instala fácil y rápidamente, y es especialmente apropiado para aplicaciones domésticas y comerciales, en las que se integra a la perfección en cualquier diseño.

Este producto ofrece el sistema de frenado con softbrake. Proporcionando así una acción deslizante suave, agradable y segura: los dedos quedan resguardados en el ciclo de cierre del panel de vidrio, y éste también está protegido de daños de impacto.

SV-X70 Oculta todos sus mecanismos dentro del perfil superior consiguiendo un moderno y minimalista aspecto estético. Este sistema se ofrece tanto para montaje a techo como para montaje a pared. Para las instalaciones de montaje a pared, presenta una característica única en que la distancia entre la pared y el panel de vidrio se puede ajustar entre un mínimo de 14mm hasta 25mm, dependiendo de los requisitos de diseño, añadiendo así una mayor versatilidad para los demás beneficios del sistema.

EN

SV-X70 is a compact sliding solution for frameless glass panels, combining latest technology with an attractive minimalist design. The system is quick and easy to install, and is particularly appropriate for domestic and commercial applications, where it integrates seamlessly into any design.

This product offers the softbrake system, thereby providing an advanced and pleasing sliding action, whilst at the same time enhancing safety; fingers are protected from being caught in the closing cycle of the glass panel, which itself is also protected from impact damage.

SV-X70 conceals all of its sliding components within the top track, giving a pleasing aesthetic appearance. SV-X70 is offered for both ceiling and wall mounted applications; for wall mounted installations, the system offers a unique feature, in that the distance between the wall and the glass panel can be adjusted between a minimal 14mm up to 25mm depending on design requirements, thereby adding a useful versatility to the other benefits of the system.

FR

SV-X70 est un système de porte coulissante pour panneaux en verre sans cadre qui combine les dernières technologies avec un attrayant-désign minimaliste. Le système a une installation facile et rapide et il est particulièrement adapté pour les applications domestiques et commerciales, et parfaitement bien intègre dans toute conception.

Ce produit offre le système de freinage Softbrake, fournissant ainsi une action de glissement fluide, agréable et sécuritaire: les doigts sont protégés dans le cycle de fermeture du panneau de verre, et ces derniers le sont également contre les chocs.

SV-X70 il cache tous ses mécanismes dans le profil supérieur avec une esthétique moderne et minimaliste. Ce système est disponible pour le montage au plafond et pour le montage mural. Pour le montage des installations de mur, il a une caractéristique unique en ce que la distance entre le mur et le panneau de verre peut être réglée entre un minimum de 14mm à 25mm, selon les exigences de la installation, ajoutant ainsi une plus grande polyvalence aux avantages de ce système.





Características técnicas

Technical characteristics | Caractéristiques techniques

Perfilería Profiles | Profils

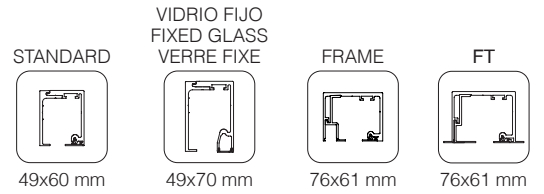

FT VIDRIO FIJO I FIXED GLASS I VERRE FIXE

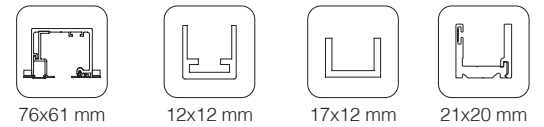

Especificaciones Specifications | Spécification

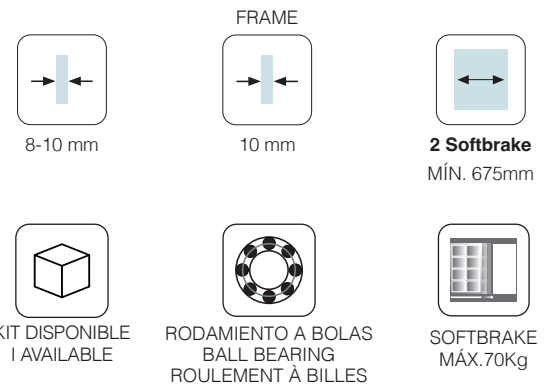

Peso Weight | Poids



Producto certificado

Certificated product | Produit certifié



Variantes de instalación

Installation possibilities | Variantes d'installation

PARED
WALL
MUR

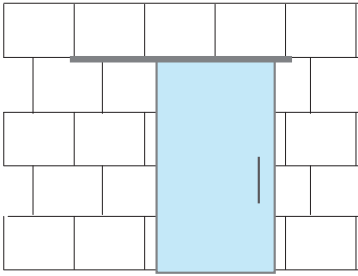

PARED CON VIDRIO FJO
WALL WITH FIXED PANEL
MUR AVEC VERRE FIXE

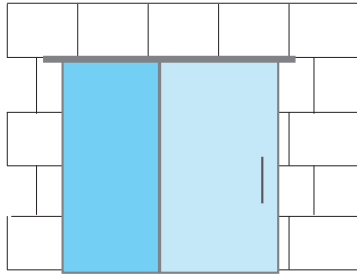

TECHO
CEILING
PLAFOND

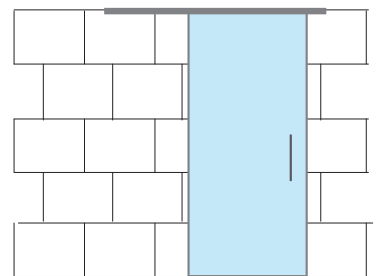

TECHO CON VIDRIO FJO
CEILING WITH FIXED PANEL
PLAFOND AVEC VERRE FIXE

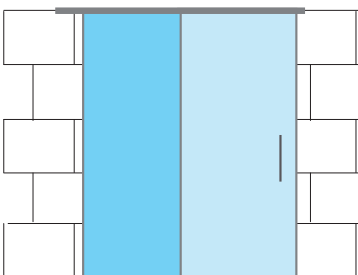

FALSO TECHO
FALSE CEILING
FAUX PLAFOND

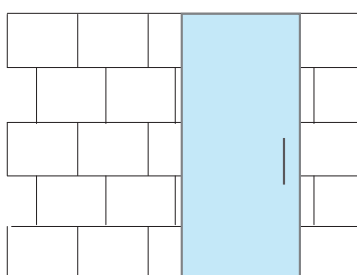

FALSO TECHO CON VIDRIO FJO
FALSE CEILING WITH FIXED PANEL
FAUX PLAFOND AVEC VERRE FIXE

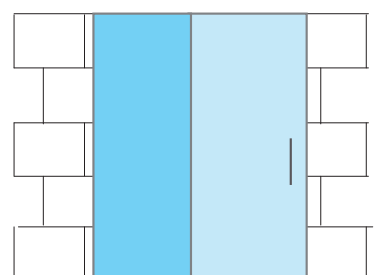

PARED DE VIDRIO
GLASS WALL
MUR DE VERRE

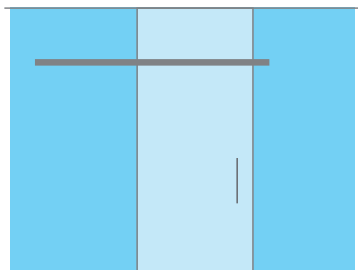

TECHO CON VIDRIO FJO
CEILING WITH FIXED PANEL
PLAFOND AVEC VERRE FIXE

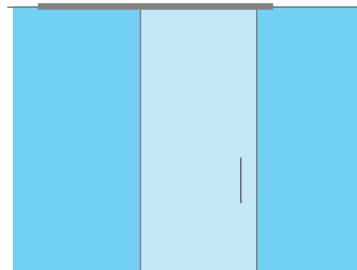

FALSO TECHO CON VIDRIO FJO
FALSE CEILING WITH FIXED PANEL
FAUX PLAFOND AVEC VERRE FIXE

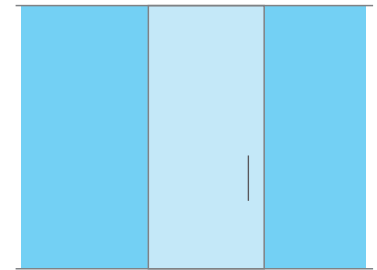

 **PUERTA CORREDERA** | SLIDING DOOR | PORTE COULISSANTE

 **VIDRIO FJO** | FIXED GLASS | VERRE FIXE



Sección tipo

Cros-section | Section type (Cotas en mm | Dimensions in mm | Dimensions en mm)

MONTAJE A PARED | WALL MOUNTING | FIXATION À MUR

Tornillo | Screw | Vis
DIN-7505 4,5x40mm

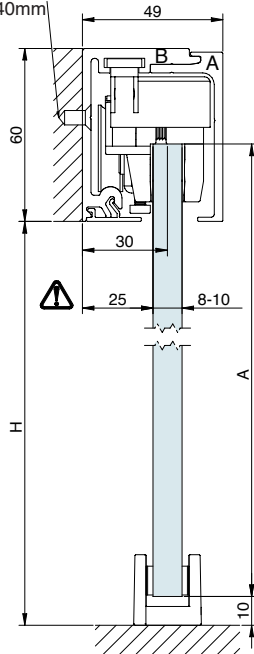

$A = H + 17$

PARED DE VIDRIO
GLASS WALL | MUR DE VERRE

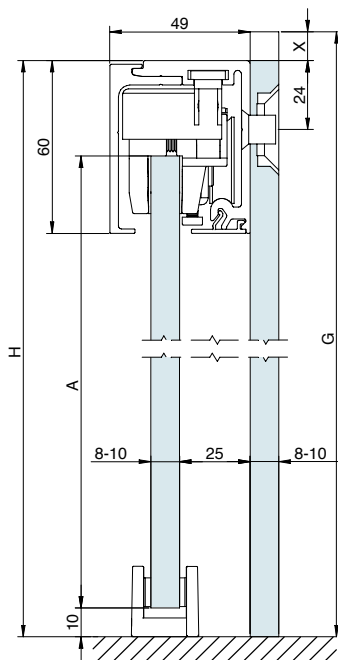

$A = H - 43$

$G = H + X$

Sección tipo

Cross-section | Section type (Cotas en mm | Dimensions in mm | Dimensions en mm)

MONTAJE A TECHO | CEILING MOUNTING | FIXATION À PLAFOND

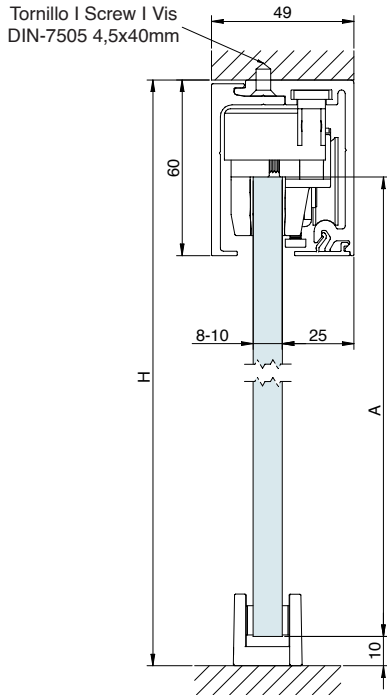

A= H-43

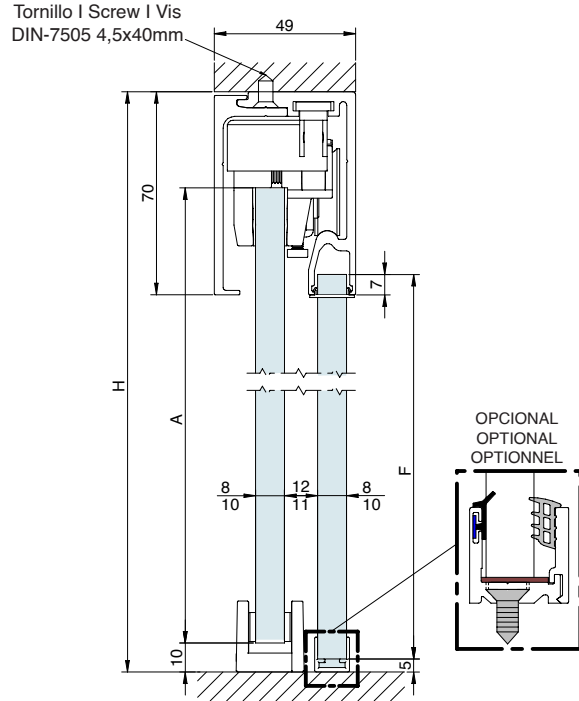

A= H-43

F= H-67

MONTAJE A FALSO TECHO | FALSE CEILING MOUNTING | FIXATION À FAUX-PLAFOND

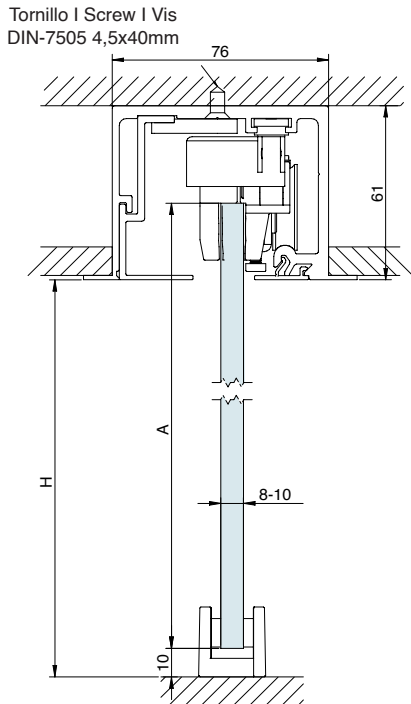

A= H+17

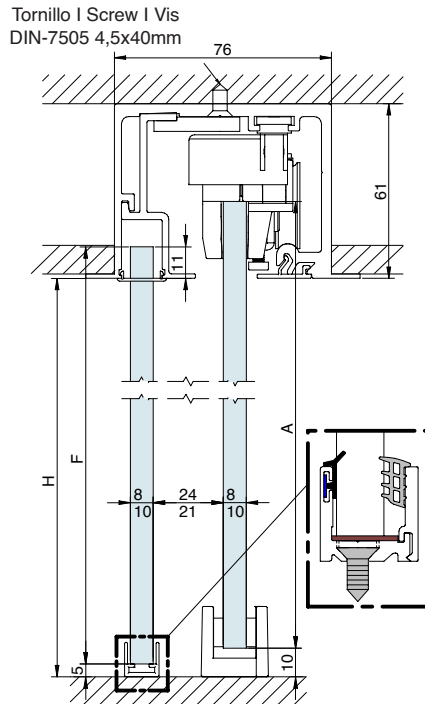







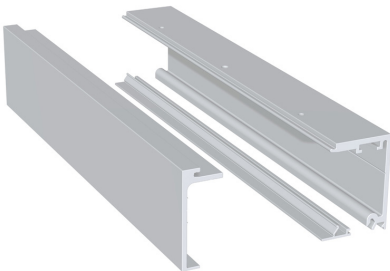

A= H+17

F= H+6



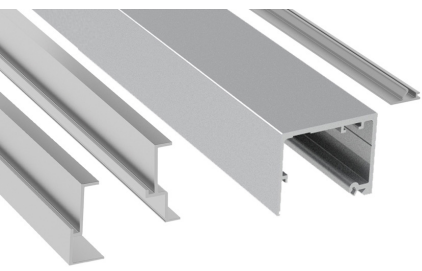

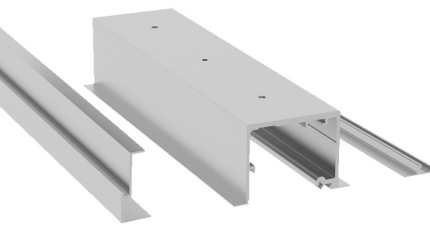



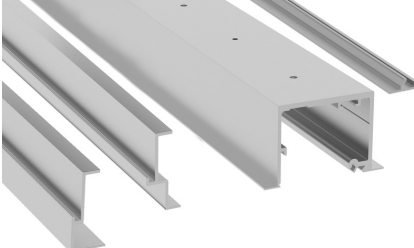

Componentes

Components | Composants

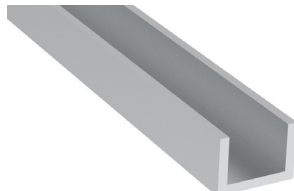
PERFILERÍA PROFILES PROFILS		Acabado	Cód.		
 <p>Conjunto perfil superior corredero Sliding top track set Jeu rail supérieur coulissant</p>  <p>49x60mm</p>	S	00 70 20	2 m	1 juego 1 set 1 jeu	
		00 70 30	3 m		
		00 70 50	5 m		
	BS	00 70 22	2 m		
		00 70 32	3 m		
		00 70 52	5 m		
	WL	00 71 20	2 m		
		00 71 30	3 m		
		00 71 50	5 m		
	BL	00 71 24	2 m		
		00 71 34	3 m		
		00 71 54	5 m		
 <p>Conjunto perfil superior corredero para vidrio fijo Sliding top track set for fixed glass Jeu rail supérieur coulissant pour verre fixe</p>  <p>49x70mm</p>	S	00 70 26	2 m	1 juego 1 set 1 jeu	
		00 70 36	3 m		
		00 70 56	5 m		
	BS	00 70 28	2 m		
		00 70 38	3 m		
		00 70 58	5 m		
	WL	00 71 21	2 m		
		00 71 31	3 m		
		00 71 51	5 m		
	BL	00 71 25	2 m		
		00 71 35	3 m		
		00 71 55	5 m		
 <p>Conjunto perfil superior corredero para accesorio Frame Sliding top track set for Frame accessory Jeu rail supérieur coulissant pour accessoire Frame</p>  <p>76x61mm</p>	S	0 109 86	2 m	1 juego 1 set 1 jeu	
		0 109 87	3 m		
		0 109 88	4 m		
	WL	0 109 89	6 m		
		0 111 86	2 m		
		0 111 87	3 m		
	BL	0 111 88	4 m		
		0 111 89	6 m		
		0 109 94	2 m		
	BL	0 109 95	3 m		
		0 109 96	4 m		
		0 109 97	6 m		
 <p>Conjunto perfil superior corredero FT. Montaje a falso techo. FT sliding top track set. False ceiling mounting. Set rail supérieur coulissant FT. Fixation à faux plafond.</p>  <p>76x61mm</p>	S	0 109 24	2 m	1 juego 1 set 1 jeu	
		0 109 34	3 m		
		0 109 44	4 m		
	BS	0 109 64	6 m		
		0 109 25	2 m		
		0 109 35	3 m		
	WL	0 109 45	4 m		
		0 109 65	6 m		
		0 119 22	2 m		
	BL	0 119 32	3 m		
		0 119 42	4 m		
		0 119 62	6 m		
BL	0 119 26	2 m			
	0 119 36	3 m			
	0 119 46	4 m			
		0 119 66	6 m		

Componentes

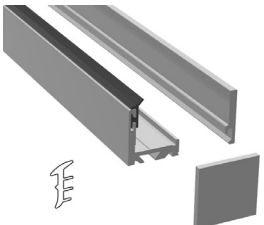
Components | Composants

PERFILERÍA PROFILES PROFILS	Acabado	Cód.		
 <p>Conjunto perfil superior corredero FT para vidrio fijo. Montaje a falso techo FT sliding top track for fixed glass set. False ceiling mounting Set rail supérieur coulissant pour verre fixe. Fixation à faux plafond.</p>  76x61mm	<p>S</p> <p>BS</p> <p>WL</p> <p>BL</p>	<p>0 109 26 0 109 36 0 109 46 0 109 66</p> <p>0 109 27 0 109 37 0 109 47 0 109 67</p> <p>0 119 23 0 119 33 0 119 43 0 119 63</p> <p>0 119 27 0 119 37 0 119 47 0 119 67</p>	<p>2 m 3 m 4 m 6 m</p> <p>2 m 3 m 4 m 6 m</p> <p>2 m 3 m 4 m 6 m</p> <p>2 m 3 m 4 m 6 m</p>	<p>1 juego 1 set 1 jeu</p>
 <p>Perfil inferior para vidrio fijo de 8-10-12mm Bottom track for fixed glass of 8-10-12mm Rail inférieur pour verre fixe de 8-10-12mm</p>  17x12mm	<p>S</p> <p>BS</p> <p>WL</p> <p>BL</p>	<p>00 87 34</p> <p>00 84 34</p> <p>00 71 91</p> <p>00 71 81</p>	<p>3 m</p>	<p>1 perfil 1 profile 1 profil</p>
 <p>Perfil inferior Leds Leds bottom track Rail inférieur Leds</p>  12x12mm	<p>S</p> <p>BS</p> <p>WL</p> <p>BL</p>	<p>0 110 30</p> <p>0 110 31</p> <p>00 71 92</p> <p>00 71 82</p>	<p>3 m</p>	<p>1 perfil 1 profile 1 profil</p>
 <p>Perfil inferior entrada frontal para vidrio fijo de 8-10-12 mm Inferior rail front entry for fixed glass of 8-10-12mm Profil inférieur entrée frontale pour verre fixe de 8-10-12mm</p>  21x20mm NEW	<p>S</p> <p>BS</p> <p>WL</p> <p>BL</p>	<p>0 110 32¹</p> <p>0 110 33¹</p> <p>0 110 34¹</p> <p>0 110 35¹</p>	<p>3 m</p>	<p>1 perfil 1 profile 1 profil</p>

¹El perfil incluye junta + juegos de tapas laterales | ¹This profile includes PVC joints + set of end caps | ¹Le profil inclue jointes plastiques + capuchons finals

2 m - 2 juegos de tapas | 2 set of caps | 2 set de caupuchons finals 3 m - 4 juegos de tapas | 4 set of caps | 4 set de caupuchons finals 6 m - 6 juegos de tapas | 6 set of caps | 6 set de caupuchons finals

S Aluminio anodizado plata mate
Satin anodized aluminium
Aluminium anodisé argent

BS Aluminio cepillado acabado Inox
Stainless Steel brushed finish aluminium
Aluminium brossé finition Inox





WL Aluminio lacado blanco mate
Matt white lacquered aluminium
Aluminium anodisé laqué blanc mat

BL Aluminio lacado negro mate
Matt black lacquered aluminium
Aluminium anodisé laqué noir mat



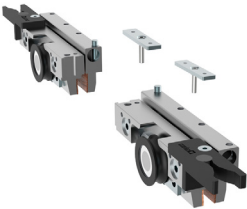

Componentes

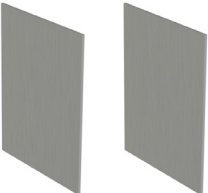
Components | Composants

JUEGOS SETS JEUX		Acabado	Cód.		
 <p>Juego accesorios SV-X70 x2 Softbrake SV-X70 Fitting set x2 Softbrake Garniture SV-X70 x2 Amortisseur</p> <p>70kg por hoja per panel par panneau</p>  <p>RODAMIENTO A BOLAS BALL BEARING ROULEMENT À BILLES</p>			00 70 01		1 juego 1 set 1 jeu
 <p>Juego accesorios SV-X70 x2 Freno retenedor SV-X70 Fitting set x2 Retaining stopper Garniture SV-X70 x2 Frein de retenue</p> <p>70kg por hoja per panel par panneau</p>  <p>RODAMIENTO A BOLAS BALL BEARING ROULEMENT À BILLES</p>			00 70 05		1 juego 1 set 1 jeu
ACCESORIOS ACCESSORIES ACCESSOIRES		Acabado	Cód.		
 <p>Juego de tapas para perfil superior. Montaje a techo o pared. End cover set for top track. Ceiling and wall mounting. Jeu de capuchons finals pour rail supérieur. Fixation à mur et à plafond.</p>	<p>S</p> <p>BS</p> <p>WL</p> <p>BL</p>	00 70 70 00 70 72 00 71 93 00 71 83			1 juego 1 set 1 jeu

Componentes

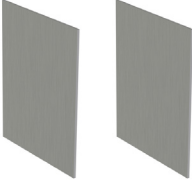
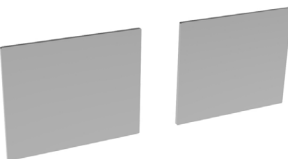
Components | Composants

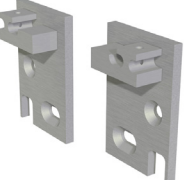
ACCESORIOS ACCESSORIES ACCESSOIRES		Acabado	Cód.		
 <p>Juego de tapas para perfil superior con vidrio fijo. Montaje a techo o pared End cover set for top track with fixed glass. Ceiling and wall mounting Jeu de capuchons finals pour profil supérieur avec verre fixe. Fixation à mur et à plafond</p>	S	00 70 71	1 juego 1 set 1 jeu		
	BS	00 70 73			
	WL	00 71 94			
	BL	00 71 84			
 <p>Juego de tapas laterales para perfil superior para accesorio Frame. Montaje a techo Lateral cap set for top track for accessory Frame. Ceiling mounting Jeu de capuchons latéraux pour rail supérieur pour accessoire Frame. Fixation à plafond.</p>	S	00 70 78	1 juego 1 set 1 jeu		
	WL	00 70 77			
	BL	00 70 79			
 <p>Soporte para pared de vidrio Glass wall support Support mur pour installation sur verre</p>		00 70 84 ¹	10 piezas 10 pieces 10 pièces		
 <p>Juego soporte flotante Set of end wall track brackets Jeu supports murales pour rail porteur</p>	S	00 70 80	1 juego 1 set 1 jeu		
	BS	00 70 81			
	WL	00 71 95			
	BA	00 71 85			

¹El perfil incluye junta + juegos de tapas laterales | ¹This profile includes PVC joints + set of end caps | ¹Le profil inclue jointes plastiques + capuchons finals

2 m - 2 juegos de tapas | 2 set of caps | 2 set de cauchuchos finals 3 m - 4 juegos de tapas | 4 set of caps | 4 set de cauchuchos finals 6 m - 6 juegos de tapas | 6 set of caps | 6 set de cauchuchos finals

WL Aluminio lacado blanco
White lacquered aluminium
Aluminium anodisé laqué blanc

S Aluminio anodizado plata mate
Satin anodized aluminium
Aluminium anodisé argent

BL Aluminio lacado negro mate
Matt black lacquered aluminium
Aluminium anodisé laqué noir mat



BS Aluminio cepillado acabado Inox
Stainless Steel brushed finish aluminium
Aluminium brossé finition Inox

BA Aluminio anodizado negro
Black anodized aluminium
Aluminium anodisé noir

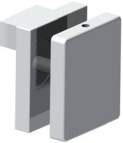
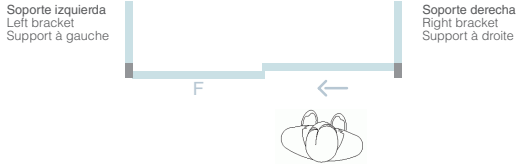

Componentes

Components | Composants

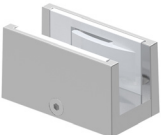
ACCESORIOS ACCESSORIES ACCESSOIRES		Acabado	Cód.		
	<p>Juego soporte flotante (Montaje enrasado) Set of end wall track brackets (Leveled assembly) Jeu supports murales pour rail porteur (Mountage arasé)</p>	GI	00 70 87		1 juego 1 set 1 jeu
	<p>Soporte flotante vidrio Mounting bracket on glass Support de montage sur verre</p>  <p>Soporte izquierda Left bracket Support à gauche</p> <p>Soporte derecha Right bracket Support à droite</p>	<p>S</p> <p>BS</p> <p>WL</p> <p>BA</p> <p>S</p> <p>BS</p> <p>WL</p> <p>BA</p>	<p>0 972 02</p> <p>0 972 03</p> <p>0 972 07</p> <p>0 972 08</p> <p>0 972 05</p> <p>0 972 06</p> <p>0 972 09</p> <p>0 972 10</p>	<p>Izquierda Left À gauche</p> <p>Derecha Right Droite</p>	1 unidad 1 unit 1 unité
	<p>Tornillería sujeción 1 metro de perfil Bolts for securing 1 metre of track Vis de fixation 1 mètre de profil</p>		0 160 73		1 juego 1 set 1 jeu
	<p>Guiador inferior para vidrio de 8-14mm Bottom guide for glass of 8-14mm Guide inférieur pour verre de 8-14mm</p>	<p>S</p> <p>BS</p> <p>WL</p> <p>BA</p>	<p>0 155 73</p> <p>0 155 79</p> <p>00 71 90</p> <p>00 71 80</p>		1 pieza 1 piece 1 pièce

GI Hierro cincado
Galvanized iron
Fer zingué

S Aluminio anodizado plata mate
Satin anodized aluminium
Aluminium anodisé argent







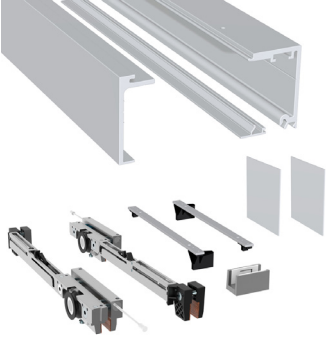

BS Aluminio cepillado acabado inox
Stainless Steel brushed finish aluminium
Aluminium brossé finition Inox

WL Aluminio lacado blanco mate
Matt white lacquered aluminium
Aluminium anodisé laqué blanc mat

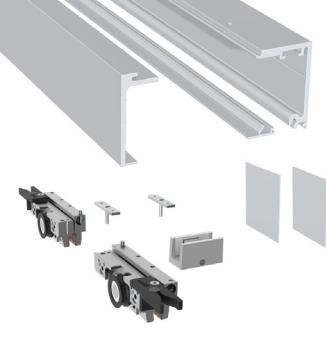
BA Aluminio anodizado negro
Black anodized aluminium
Aluminium anodisé noir

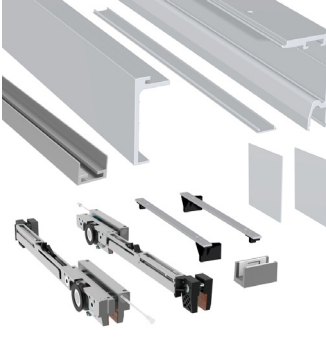
Componentes

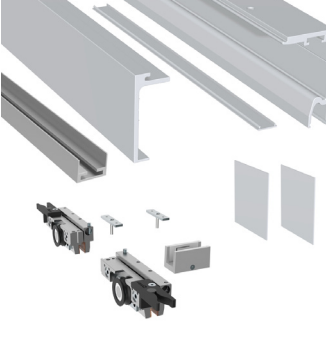
Components | Composants

KITS KITS KITS		Acabado	Cód.		
 <p>Kit SV-X70 x2 Softbrake SV-X70 kit x2 Softbrake Kit SV-X70 x2 Amortisseur</p> <p>70kg por hoja per panel par panneaux</p>  49x60mm  RODAMIENTO A BOLAS BALL BEARING ROULEMENT À BILLES	S	0 970 01 0 970 02	2 m 3 m	1 kit 1 jeu	
	BS	0 970 05 0 970 06	2 m 3 m		
	BL	0 970 70 0 970 71	2 m 3 m		
 <p>Kit SV-X70 x2 Freno retenedor SV-X70 kit x2 Retaining stopper Kit SV-X70 x2 Freins de retenue</p> <p>70kg por hoja per panel par panneaux</p>  49x60mm  RODAMIENTO A BOLAS BALL BEARING ROULEMENT À BILLES	S	0 970 33 0 970 34	2 m 3 m	1 kit 1 jeu	
	BS	0 970 37 0 970 38	2 m 3 m		
	BL	0 970 72 0 970 73	2 m 3 m		
 <p>Kit SV-X70 para vidrio fijo x2 Softbrake SV-X70 kit for fixed glass x2 Softbrake Kit SV-X70 pour verre fixe x2 Amortisseur</p> <p>70kg por hoja per panel par panneaux</p>  49x70mm  RODAMIENTO A BOLAS BALL BEARING ROULEMENT À BILLES	S	0 970 41 0 970 42	2 m 3 m	1 kit 1 jeu	
	BS	0 970 43 0 970 44	2 m 3 m		
	BL	0 970 74 0 970 75	2 m 3 m		
 <p>Kit SV-X70 para vidrio fijo x2 Freno retenedor SV-X70 kit for fixed glass x2 Retaining stopper Kit SV-X70 pour verre fixe x2 Frein de retenue</p> <p>70kg por hoja per panel par panneaux</p>  49x70mm  RODAMIENTO A BOLAS BALL BEARING ROULEMENT À BILLES	S	0 970 57 0 970 58	2 m 3 m	1 kit 1 jeu	
	BS	0 970 59 0 970 60	2 m 3 m		
	BL	0 970 76 0 970 77	2 m 3 m		

S Aluminio anodizado plata mate
 Satin anodized aluminium
 Aluminium anodisé argent

BS Aluminio cepillado acabado Inox
 Stainless Steel brushed finish aluminium
 Aluminium brossé finition Inox

BL Aluminio lacado negro mate
 Matt black lacquered aluminium
 Aluminium anodisé laqué noir mat



Componentes

Components | Composants

ACCESORIO FRAME FRAME ACCESSORIE ACCESSOIRE FRAME Conjunto división interna Internal division set Kit de division interne		Acabado	Cód.			
<p>Conjunto marco perimetral para puerta corredera Perimeter frame set for sliding door Kit cadre périmétral pour porte coulissante</p> 10x10mm 19x10mm 39x10mm	S WL BL	0 111 22 0 111 41 0 111 27	<p>3 m 2 m</p>	<p>1 juego 1 set 1 jeu</p>		
	S WL BL	0 111 12 0 111 42 0 111 13			<p>2,5 m 1 m</p>	<p>1 juego 1 set 1 jeu</p>
	<p>Conjunto división interna Internal division set Kit division interne</p> 10x10mm 19x10mm	S WL BL	0 111 20 0 111 43 0 111 25	<p>3m</p>		
<p>Conjunto marco perimetral para vidrio fijo. Compatible con perfil Frame y perfil FT vidrio fijo. Perimeter frame for fixed glass. Compatible with Frame track and FT fixed glass track. Kit de cadre périmétral pour verre fixe. Compatible avec le rail Frame et le rail FT verre fixe.</p> 17x12mm 10x10mm 19x10mm 39x10mm	S WL BL	0 111 28 0 111 44 0 111 29	<p>3m 2m</p>	<p>1 juego 1 set 1 jeu</p>		
	S WL BL	0 111 14 0 111 45 0 111 15			<p>2,5 m 1 m</p>	<p>1 juego 1 set 1 jeu</p>
	<p>Conjunto tiradores Frame Frame handles Poignées Frame</p>	S WL BL	0 111 32 0 111 31 0 111 37		<p>1 juego 1 set 1 jeu</p>	

Compact Glass

SV-X70



Polígono Industrial de Foradada / 08580
St. Quirze de Besora / Barcelona / Spain
T +34 93 852 92 23
saheco@saheco.com

Export contact details
T +34 93 852 96 15
export@saheco.com
saheco.com